

Birou Comercial: Str. Monumentului nr. 25, loc. Bragadiru, jud. Ilfov, cod postal 077025  
Tel.: 0371.472.811; 0371.472.813; mobil: 0766.26.76.50; Fax: 031.107.05.86; 0378.104.208; 0372.878.080  
E-mail: office@mdmstandard.ro; www.mdmstandard.ro; Sediul social: Str. Cosoveni nr. 7, Bucuresti, Sector 5;  
C.U.I.: RO11451006; Nr.Reg.Com: J40/13069/1998; Cont: RO60BRDE441SV82122524410; BRD-Ag. 13 Septembrie

**Produsele sunt disponibile in limita stocului**

Nr. Crt.	Denumirea si caracteristicile produsului	Pret/buc fara TVA [Eur]	Pret cu discount/buc fara TVA [Eur]
1.	Subler digital exterior-interior-adancime, domeniu de masurare 0 – 200 mm, protectie IP 67, fabricatie Mitutoyo		
		279.00	153.10
	Cod produs: 500-707-20		
2.	Subler digital exterior, domeniu de masurare 0 – 300 mm, protectie IP 67, fabricatie Mitutoyo		
		550.00	363.20
	Cod produs: 550-331-20		
3.	Subler digital exterior-interior-adancime mm/inch, domeniu de masurare 0 – 75 mm / 0 – 3 “, fabricatie Insize		
		36.30	22.70
	Cod produs: 1111-75		
4.	Subler digital exterior-interior-adancime mm/inch, domeniu de masurare 0 – 300 mm / 0 – 12 “, protectie IP 67, fabricatie Insize		
		140.50	87.80
	Cod produs: 1126-300W		
5.	Subler digital exterior-interior mm/inch, domeniu de masurare 0 – 600 mm / 0 – 24 “, lungime falci 100 mm, fabricatie Insize		
		317.00	198.30
	Cod produs: 1136-601		

- 
6. Subler Vernier exterior-interior-adancime, domeniu de masurare 0 – 70 mm, fabricatie Insize



17.30

10.80

Cod produs: 1204-70

---

7. Subler Vernier exterior-interior-adancime mm / inch, domeniu de masurare 0 – 150 mm / 0 – 6 “, fabricatie Insize



18.10

13.20

Cod produs: 1205-150S

---

8. Subler Vernier exterior-interior-adancime mm / inch, domeniu de masurare 0 – 200 mm / 0 – 8 “, fabricatie Insize



35.40

22.20

Cod produs: 1205-200S

---

9. Subler cu cadran exterior-interior-adancime, domeniu de masurare 0 – 150 mm, fabricatie Insize



43.60

27.30

Cod produs: 1311-150A

---

10. Subler digital adancime mm / inch, domeniu de masurare 0 – 300 mm / 0 – 12 “, lungime baza 150 mm, fabricatie Insize



129.00

80.70

Cod produs: 1141-300A

---

11. Baza pentru masurarea adancimii , lungime baza 125 mm, fabricatie Insize



36.10

23.00

Cod produs: 6140-300A

---

12. Micrometru de exterior digital mm / inch, domeniu de masurare 25 – 50 mm / 1 – 2 “, fabricatie Insize



106.00

66.20

Cod produs: 3108-50A

---

- 
13. Micrometru de exterior digital mm / inch, domeniu de masurare 25 – 50 mm / 1 – 2 “, fabricatie Insize



79.70

49.80

Cod produs: 3109-50A

---

14. Micrometru de exterior digital mm / inch, domeniu de masurare 50 – 75 mm / 2 – 3 “, fabricatie Insize



96.30

63.20

Cod produs: 3109-75A

---

15. Micrometru de exterior Vernier, domeniu de masurare 0 – 25 mm, fabricatie Insize



16.50

12.00

Cod produs: 3202-25A

---

16. Micrometru de exterior Vernier, domeniu de masurare 25 – 50 mm, fabricatie Insize



21.30

13.30

Cod produs: 3202-50A

---

17. Micrometru de exterior Vernier, domeniu de masurare 50 – 75 mm, fabricatie Insize



29.10

18.20

Cod produs: 3202-75A

---

18. Micrometru de exterior Vernier, domeniu de masurare 0 – 25 mm, fabricatie Insize



16.70

12.20

Cod produs: 3203-25A

---

- 
19. Micrometru de exterior Vernier, domeniu de masurare 25 – 50 mm, fabricatie Insize



21.40

13.70

Cod produs: 3203-50A

---

20. Micrometru de exterior Vernier, domeniu de masurare 50 – 75 mm, fabricatie Insize



27.90

17.50

Cod produs: 3203-75A

---

21. Stand pentru micrometru, fabricatie Insize



17.60

11.00

Cod produs: 6301

---

22. Comparator digital mm / inch, lungime cursa de masurare 12.7 mm / 0.5 ", fabricatie Insize



56.70

35.40

Cod produs: 2112-10F

---

23. Comparator cu cadran, lungime cursa de masurare 10 mm, lug back, fabricatie Insize



19.90

12.50

Cod produs: 2308-10A

---

24. Comparator cu cadran, lungime cursa de masurare 10 mm, flat back, fabricatie Insize



19.50

12.40

Cod produs: 2308-10FA

---

25. Pupitast cu cadran, lungimea cursa de masurare 0.2 mm, fabricatie Insize



67.90

42.50



Cod produs: 2381-02

26. Dispozitiv pentru masurarea grosimii mm / inch, domeniu de masurare 0 – 10 mm / 0 – 0.4 “, fabricatie Insize



216.00

135.00

Cod produs: 2871-101

27. Palpator cu bila M2.5X0.45, L 12.1, fabricatie Insize

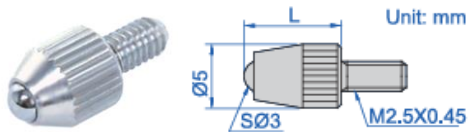

3.80

2.40

Cod produs: 6282-0106

28. Stand magnetic pentru comparator, fabricatie Insize

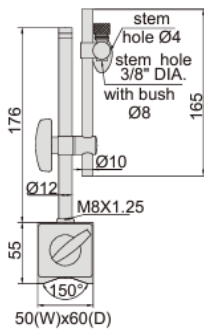

20.30

12.70

Cod produs: 6200-60

29. Nivelă, fabricatie Insize



37.80

23.60

Cod produs: 2170-1

30. Raportor digital, domeniu de masurare 0° – 360°, lungime rigla 200 mm, gradatie rigla 1 mm, fabricatie Insize



22.50

14.10

Cod produs: 2176-200

31. Sablon sudura, fabricatie Insize

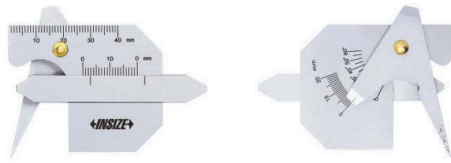

36.80

23.00

Code	Measurement	Range	Graduation	Accuracy
6832-1	leg length	0-20mm	1mm	±0.3mm
	leg height	0-20mm	1mm	±0.3mm
	crown height	0-20mm	1mm	±0.3mm
	throat size	0-10mm	1mm	±0.3mm
	angle	0°-60°	5°	±1°
	gap	1-3.5mm	0.5mm	±0.2mm
	length	0-40mm	1mm	±0.3mm

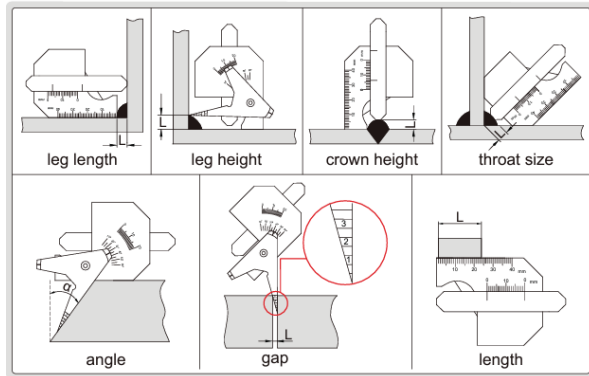

Cod produs: 6832-1

32. Subler Vernier pentru sudura, crown height 0 – 8 mm, fillet weld throat size 0 – 20 mm, fabricatie Insize

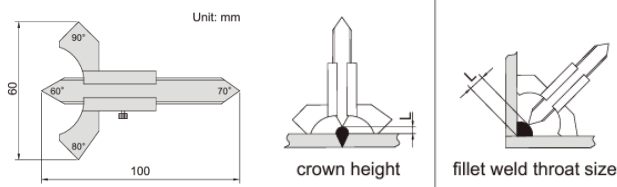

25.20

15.80

Cod produs: 4830

33. Subler digital pentru sudura, crown height 0 – 7 mm, fillet weld throat size 0 – 20 mm, fabricatie Insize

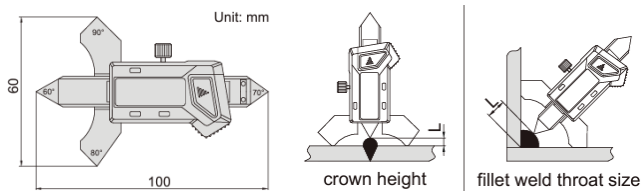

73.30

45.80

Cod produs: 4831-20A

34. Sablon pentru sudura, fabricatie Insize

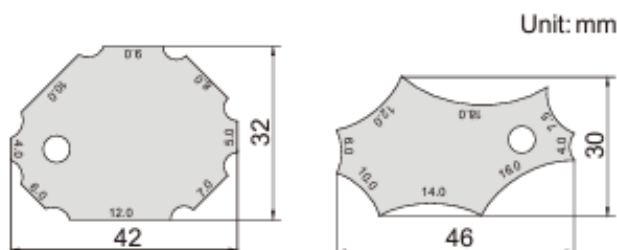

11.10

7.00

Cod produs: 4832-1

35. Sablon pentru sudura, fabricatie Insize

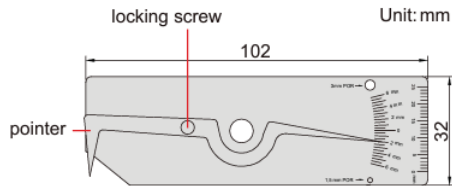

21.50

13.50

Cod produs: 4834-1

36. Sablon pentru sudura, fabricatie Insize



30.90

19.30

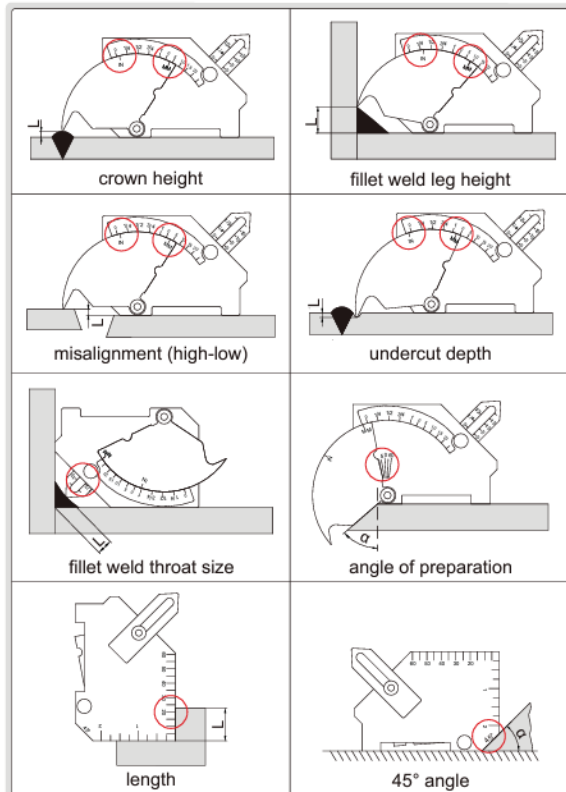

Code	Measurement	Range	Graduation	Accuracy
4835-1	crown height	0-25mm (0-1")	1mm (1/16")	±0.5mm
	fillet weld leg height	0-25mm (0-1")	1mm (1/16")	±0.5mm
	misalignment (high-low)	0-25mm (0-1")	1mm (1/16")	±0.5mm
	undercut depth	0-2mm (0-1/8")	1mm (1/16")	±0.5mm
	fillet weld throat size	0-20mm (0-3/4")	1mm (1/16")	±0.5mm
	angle of preparation	0-60°	5°	±1°
	length	0-60mm (0-2")	1mm (1/16")	±0.5mm
	45° angle	—	—	±1°

Cod produs: 4835-1

37. Sablon pentru sudura, fabricatie Insize

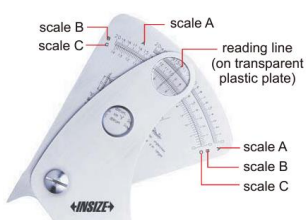

35.60

22.30

Cod produs: 4840-1

38. Sablon pentru sudura, fabricatie Insize

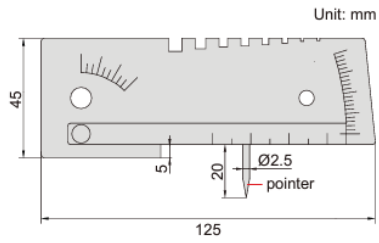

29.30

18.10

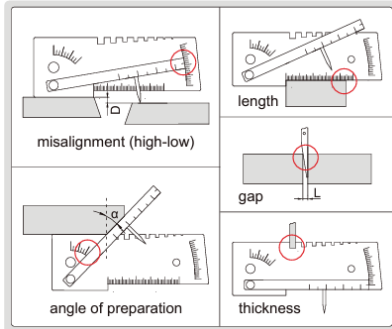

Code	Measurement	Range	Graduation	Accuracy
4848-1	misalignment (high-low)	-5mm~+15mm	1mm	±0.5mm
	angle of preparation	0°-45°	5°	±2.5°
	length	0-50mm	1mm	±0.5mm
	gap	1-4mm	0.5mm	±0.25mm
	thickness	1, 1.2, 2.0, 2.5, 3.0, 3.25, 4.0, 5.0mm	—	±0.1mm

Cod produs: 4848-1

39. Set lere de sudura, fabricatie Insize



24.00

15.00

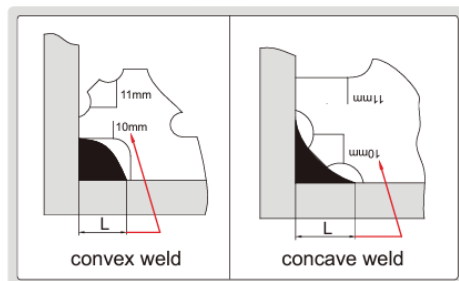

Code	Size	Accuracy
4836-1	3mm, 4mm, 5mm, 6mm, 8mm, 9mm, 10mm, 11mm, 12mm, 14mm, 16mm, 19mm, 22mm, 25mm	±0.5mm

Cod produs: 4836-1



40. Set lere de sudura, fabricatie Insize



14.90

9.30

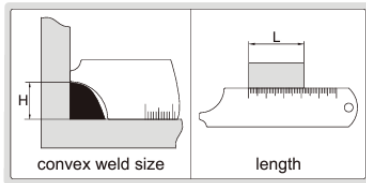

Code	Measurement	Range	Graduation	Accuracy
4847-1	convex weld size	4, 6, 8, 10, 12, 14mm	—	±0.5mm
	length	0-50mm	1mm	±0.5mm

Cod produs: 4847-1

41. Lera pentru cutite, fabricatie Insize



27.10

17.80

Cod produs: 4854-1

42. Set lere de grosime, fabricatie Insize



5.30

3.30

Code	Range	Thickness of leaves included (mm)	Quantity of leaves
4601-25	0.04-1.00mm	0.04, 0.05, 0.06, 0.07, 0.08, 0.09, 0.10, 0.15, 0.20, 0.25, 0.30, 0.35, 0.40, 0.45, 0.50, 0.55, 0.60, 0.65, 0.70, 0.75, 0.80, 0.85, 0.90, 0.95, 1.00	25

Cod produs: cod???

43. Set lere de grosime, fabricatie Insize

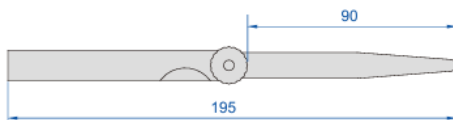

4.70

2.90

Code	Range	Thickness of leaves included (mm)	Quantity of leaves
4602-13A	0.03-0.50mm	0.03, 0.04, 0.05, 0.06, 0.07, 0.08, 0.09, 0.10, 0.15, 0.20, 0.30, 0.40, 0.50	13

Cod produs: 4602-13A

44. Set lere de grosime, fabricatie Insize

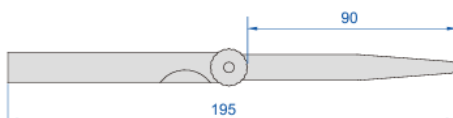

4.60

2.90

Code	Range	Thickness of leaves included (mm)	Quantity of leaves
4602-20	0.05-1.00mm	0.05, 0.10, 0.15, 0.20, 0.25, 0.30, 0.35, 0.40, 0.45, 0.50, 0.55, 0.60, 0.65, 0.70, 0.75, 0.80, 0.85, 0.90, 0.95, 1.00	20

Cod produs: 4602-20

45. Set lere de grosime, fabricatie Insize

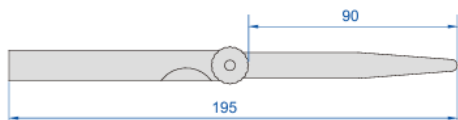

7.40

4.60

Code	Range	Thickness of leaves included (mm)	Quantity of leaves
4602-28	0.05-1.00mm	0.05, 0.06, 0.07, 0.08, 0.09, 0.10, 0.11, 0.12, 0.13, 0.14, 0.15, 0.20, 0.25, 0.30, 0.35, 0.40, 0.45, 0.50, 0.55, 0.60, 0.65, 0.70, 0.75, 0.80, 0.85, 0.90, 0.95, 1.00	28

Cod produs: 4602-28

46. Set lere de grosime, fabricatie Insize

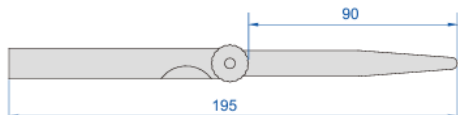

7.60

4.80

Code	Range	Thickness of leaves included (mm)	Quantity of leaves
4602-32	0.03-1.00mm	0.03, 0.04, 0.05, 0.06, 0.07, 0.08, 0.09, 0.10, 0.13, 0.15, 0.18, 0.20, 0.23, 0.25, 0.28, 0.30, 0.33, 0.35, 0.38, 0.40, 0.45, 0.50, 0.55, 0.60, 0.63, 0.65, 0.70, 0.75, 0.80, 0.85, 0.90, 1.00	32

Cod produs: 4602-32

47. Set lere de grosime, fabricatie Insize



11.70

7.40

Code	Range	Radius of leaves included (mm)	Quantity of leaves (internal + external)
4801-15	15.5-25mm	15.5, 16, 16.5, 17, 17.5, 18, 18.5, 19, 19.5, 20, 21, 22, 23, 24, 25	15+15

Cod produs: 4801-15

48. Lupa bifocala cu iluminare LED, marire 2X si 4X, fabricatie Insize



23.10

14.50



Cod produs: 7512-1

49. Lupa pliabila cu iluminare LED, marire 10X, fabricatie Insize



7.00

4.40

Cod produs: 7515-10

50. Ochelari cu set de 5 lupe (marire 1X, 1.5X, 2X, 2.5X, 3.5X) cu iluminare LED, fabricatie Insize



17.40

10.90

Cod produs: 7523-3D5

51. Cronometru digital, domeniu de masurare 0 s – 9h, 59min, 59.99s, rezolutie 0.01s, fabricatie Insize



39.70

24.80

Cod produs: DSW-A010

52. Multimetru digital smart, fabricatie Insize



55.10

35.80

Function	Range	Resolution	Accuracy
DC Voltage	60mV/600mV/6V/60V/600V	0.01mV/0.1mV/0.001V/0.01V/0.1V	±(0.5%+3)
AC Voltage	60mV/600mV/6V/60V/600V	0.01mV/0.1mV/0.001V/0.01V/0.1V	±(1.0%+3)
DC Current	6000µA/60mA/600mA	1µA/0.01mA/0.1mA	±(1.2%+5)
AC Current	6000µA/60mA/600mA	1µA/0.01mA/0.1mA	±(1.5%+5)
Resistance	600Ω/6kΩ/60kΩ/600kΩ	0.1Ω/0.001kΩ/0.01kΩ/0.1kΩ	±(1.0%+5)
	6MΩ/60MΩ	0.001MΩ/0.01MΩ	±(1.5%+3)
Capacitance	6nF/60nF/600nF/6µF/60µF/600µF	0.001nF/0.01nF/0.1nF/0.001µF/0.01µF/0.1µF	±(4.0%+5)
	6mF/60mF	0.001mF/0.01mF	±(5.0%+5)
Frequency	10Hz/100Hz/1000Hz/10kHz/100kHz/1000kHz	0.001Hz/0.01Hz/0.1Hz/0.001kHz/0.01kHz/0.1kHz	±(1.0%+5)
	10MHz	0.001MHz	±(3.0%+5)
Duty cycle	1~99%	0.1%	±(3.0%+5)
Diode measurement	open circuit voltage 2.0V		
Continuity measurement	<50Ω		
Power	2×3V CR2032 batteries		
Dimension (LxWxH)	133×68×18mm		
Weight	178g		

Cod produs: 9247-190

53. Multimetru digital tip stilou, fabricatie Insize



43.40

28.00

Function	Range	Resolution	Accuracy
DC Voltage	200mV/2V/20V/200V/600V	0.1mV/1mV/10mV/0.1V/1V	±(0.7%+2)
AC Voltage	200mV/2V/20V/200V	0.1mV/1mV/10mV/0.1V	±(0.8%+3)
	600V	1V	±(1.0%+3)
DC Current	20mA/200mA	10µA/0.1mA	±(1.5%+3)
AC Current	20mA/200mA	10µA/0.1mA	±(2.0%+3)
Resistance	200Ω	0.1Ω	±(1.0%+3)
	2kΩ/20kΩ/200kΩ/2MΩ	1Ω/10Ω/0.1kΩ/1kΩ	±(1.0%+1)
	20MΩ	10kΩ	±(1.0%+5)
Logic level test	<1.5V (green LED on) 1.5~3.5V (green & red LED off) >3.5V (red LED on)		
Diode	open circuit voltage 1.5V		
Continuity buzzer	<50Ω		
Power supply	2×1.5V AAA batteries		

Cod produs: 9241-ML200

---

54. Inel de setare, diametru exterior  $\varnothing 45$  mm, diametru interior  $\varnothing 16$  mm, grosime 12 mm, fabricatie Insize

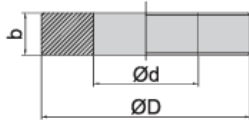

45.00

28.20

Cod produs: 6312-16

---

55. Recuperator magnetic flexibil cu gheare si iluminare, fabricatie Insize



8.35

5.20

Cod produs: 7164-1

---